

TACO DE NYLON TRIPLE EXPANSIÓN EXTENDED NYLON ANCHOR WITH WINGS

FICHA TÉCNICA TECHNICAL DATA SHEET



CÁLCULO DE LA LONGITUD DEL TORNILLO CALCULATION OF SCREW LENGTH

$L_v =$	$L_t + t_{fix}$
$h_1 =$	Profundidad mínima agujero / Min. hole depth
$L_t =$	Longitud del taco / Anchor length
$L_v =$	Longitud del tornillo / Screw length
$d_o =$	Diámetro del agujero / Hole diameter
$d =$	Diámetro del tornillo / Screw diameter
$t_{fix} =$	Espesor fijable / Fixable thickness

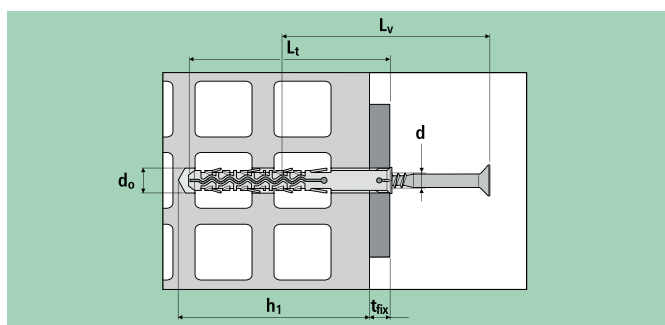

El taco de nylon triple expansión "TNT" tiene una parte de expansión que tiene doble longitud. Esto permite su uso a través de la fijación en soportes semisólidos.

- Collar avellanado especial para evitar que el anclaje se deslice en el agujero.
- La versión con 10 mm de diámetro renueva su diseño con 8 aletas que evitan la rotación y el tipo de ranura en "S" para asegurar una inserción correcta y rápida de los tornillos y la perfecta expansión del anclaje. Esto garantiza una fijación de seguridad incluso en materiales vacíos y huecos. El taco de nylon triple expansión viene completo con tornillo de madera de acero (clase 5.8) cincado blanco (capa $\geq 5\mu$):

- Avellanado con impronta PZ (PoziDrive).
- Cabeza hexagonal (Tilo Barraquero DIN 571).

Aplicación

Adecuado para soportes semisólidos: ladrillo hueco, soportes vacíos; con $\varnothing 8$ mm se puede utilizar incluso sobre soportes vacíos y placas de yeso.

Diseñado como anclaje pasante.

Material

POLIAMIDA (Nylon) - Color: gris RAL 7035.

The nylon plug "TNT" has an expanding part having double length. This allows the use for through fastening on semisolid supports.

- Special countersunk collar to prevent anchor slipping in the hole.
- The version with 10 mm diameter renews its design with 8 flaps prevent rotation and "S" slot type to assure a correct and rapid screw insertion and the perfect anchor expansion. This guarantees a safety fixing even on empty and hollow materials.

The nylon plug "TNT" comes complete with steel (class 5.8) white zinc plated (layer $\geq 5\mu$) wood screw:

- countersunk cross slotted flat head.
- hexagonal head.

Application

Suited for semisolid supports: hollow brick, empty supports; with $\varnothing 8$ mm can be used even on empty supports and plasterboard.

Designed for a through fastening.

Material

POLYAMIDE (Nylon) - Colour: grey RAL 7035.

INSTALACIÓN / INSTALLATION

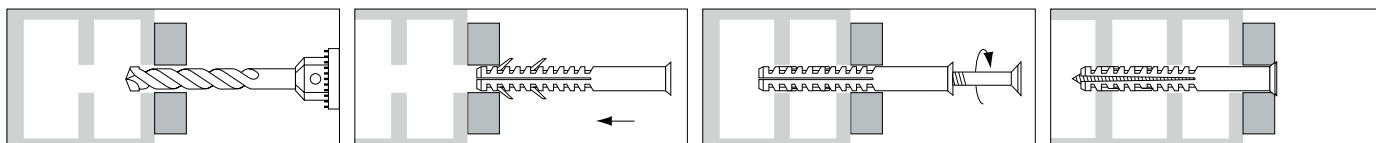



TACO DE NYLON TRIPLE EXPANSIÓN EXTENDED NYLON ANCHOR WITH WINGS

FICHA TÉCNICA TECHNICAL DATA SHEET

TNT - TACO DE NYLON / NYLON PLUG



CÓDIGO CODE	MEDIDA SIZE $d_o \times L_t$ m.m.	BROCA DRILL d_o m.m.	TORNILLO SCREW d m.m.		
					
TNT08080	8x80	8	5,5	100	1.200
TNT08100	8x100	8	5,5	50	600
TNT08120	8x120	8	5,5	50	600
TNT10080	10x80	10	7	50	600
TNT10100	10x100	10	7	50	600
TNT10135	10x140	10	7	50	300
TNT10160	10x160	10	7	50	300



TNTT - TACO DE NYLON CON TLLO. BARRAQUERO DIN 571 / NYLON PLUG WITH HEXAGONAL HEAD SCREW



CÓDIGO CODE	MEDIDA SIZE $d_o \times L_t$ m.m.	BROCA DRILL d_o m.m.	TORNILLO SCREW $d \times L_v$ m.m.	ESP. A FIJAR FIX. THICK. t_{fx} m.m.	LLAVE KEY Nº		
							
TNTT08080	8x80	8	5,5x80	5	10	100	1.200
TNTT08100	8x100	8	5,5x100	25	10	50	600
TNTT08120	8x120	8	5,5x120	45	10	50	300
TNTT10080	10x80	10	7x80	5	12	50	300
TNTT10100	10x100	10	7x100	25	12	50	300
TNTT10140	10x140	10	7x120	45	12	50	300
TNTT10160	10x160	10	7x160	85	12	50	300

TNTTC - TACO DE NYLON CON TLLO. PZ / NYLON PLUG WITH PZ SCREW



CÓDIGO CODE	MEDIDA SIZE $d_o \times L_t$ m.m.	BROCA DRILL d_o m.m.	TORNILLO SCREW $d \times L_v$ m.m.	ESP. A FIJAR FIX. THICK. t_{fx} m.m.	LLAVE KEY Nº		
							
TNTTC08080	8x80	8	5,5	5	3	50	1.200
TNTTC08100	8x100	8	5,5	25	3	25	600
TNTTC08120	8x120	8	5,5	45	3	25	600
TNTTC10080	10x80	10	7	5	4	25	600
TNTTC10100	10x100	10	7	25	4	25	600
TNTTC10140	10x140	10	7	45	4	25	300
TNTTC10160	10x160	10	7	85	4	25	300